

# MaxiFil Clean

Art. No.: 67 252 102



## Technical Data

Filter	
Filter method	Cleanable filter
Filter cleaning method	Rotating nozzle
Filter surface	161 ft <sup>2</sup>
Type of filter	Filter cartridge
Filter material	ePTFE membrane
Filter efficiency	> 99,9 %
Dust classification	M
Additional filters	Spark pre-separator made of aluminium mesh
Basic data	
Extraction capacity	853 cfm
Max. fan performance	2648 cfm
Maximum vacuum	13 inch WC
Dimensions (w x t x h)	32,8 x 38,3 x 53,1 in
Weight	435 lbs
Motor power	2,2 kW
Motor power	2.95 hp
Power supply	3 x 600 V / 60 Hz
Rated current	4.4 A
Control voltage	24 V, DC
Noise level	73 dB(A)
Additional information	
Fan type	Radial fan
Compressed air supply	73 - 87 PSI
Quantity of extraction arms	1
Exhaust arm type	flexible exhaust arm
Diameter extraction arm	6 in
Length of exhaust arm	13 ft

## Applications

- Suitable for all materials, including high-alloy steel
- High levels of smoke and particles
- Non-stop operation

## Benefits

- Safe operation by rotation field control
- Exhaust arm requires less adjustment due to flow-optimised exhaust hood design
- Increased safety due to filter monitoring
- Very economic due to long lasting high capacity filters

## Properties

- Automatic filter cleaning
- Exhaust arm up to 13 ft
- Cleanable filter
- Rotating exhaust hood
- Easy to use: Intuitive & ergonomic one-button operation
- Disposal of welding fumes in disposable bags
- Spark pre-separator made of aluminium mesh

## Accessories

- Automatic start-stop
- Workplace lighting incl. on/off switch at the hood



Suitable for alveole exchangeable dusts  
separation > 99 % of particles < 0,4 µm



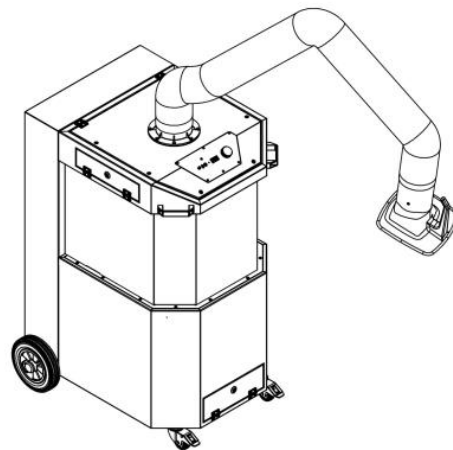
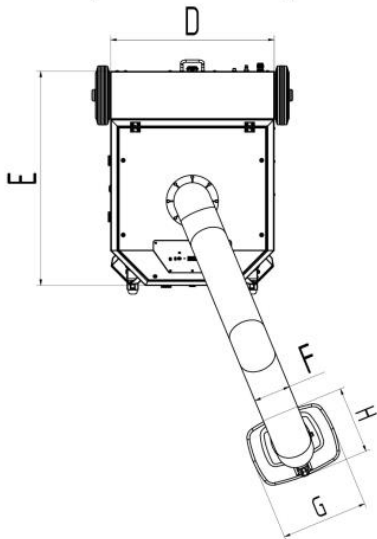
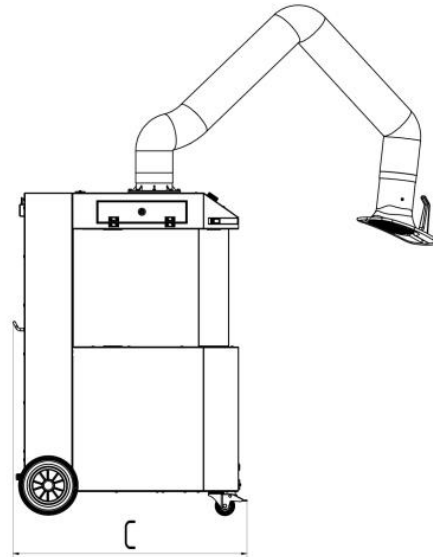
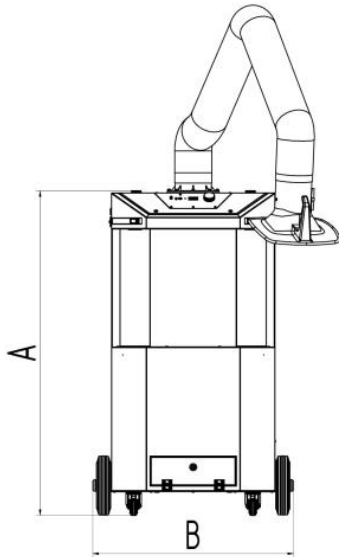

## Technical Data

### Dimensions

A	53.1 in
B	32.8 in
C	38,3 in
D	26,8 in
E	35 in
F	5,9 in
G	14,2 in
H	11,6 in